

STUNT FLYER™

— THE —
Precision Aerobatics
FLIGHT SIMULATOR



**INSTRUCTION
MANUAL**

STUNT FLYER™

Programmed by Nice Ideas
Sophia Antipolis, France

Aerobatic Consultant - Alan Gerringier

Instructional Manual by Annette Gerth Childs

TABLE OF CONTENTS

INTRODUCTION	3
A NOTE FROM THE DESIGNERS	4
AEROBATICS: YESTERDAY AND TODAY	5
The Origins of Aerobatics	5
Aerobatics Today	6
LESSON ONE: GETTING TO KNOW YOUR PLANE	7
Airplane Construction	7
The Controls	8
Throttle	8
Elevators	8
Ailerons	8
Rudder	8
LESSON TWO: PRINCIPLES OF AERODYNAMICS	9
Lift	9
Lift vs. Weight and Thrust vs. Drag	10
Stall	11
G-Force	12
The Three Axes of Movement	13
Roll	14
Pitch	15
Yaw	16
LESSON THREE: MONITORING PERFORMANCE	17
The Gauges	17
Air Speed Indicator	17
Attitude Indicator	17
Altimeter	17
Controls Indicator	17
Tachometer	17
Turn Coordinator	17
The Slipballs	18
Heading Indicator	18
Vertical Velocity Indicator	18
G-meter	18
Position Indicator	18
LESSON FOUR: KNIFE-EDGE FLIGHT AND INVERTED FLIGHT	19
Knife Edge Flight	19
Inverted Flight	20
In-Between Attitudes	20
LESSON FIVE: START YOUR ENGINE	21
The Menus	21
The Airshow	21

Aerobatic Training	21
Replay and Judging	21
The Competition	21
Computer Controls	22
Keyboard Controls	22
Joystick Controls	22
LESSON SIX: THE FOUR BASIC MANEUVERS	23
Slow Roll	23
The Inside Loop	24
The Hammerhead	25
The Spin	26
LESSON SEVEN: DEVELOPING THE BASICS	27
Developing the Roll	27
One-half Roll to Inverted	27
One-half Roll from Inverted	27
4-point Hesitation Roll	28
8-point Hesitation Roll	28
360° Rolling Circle (four Rolls to Outside)	29
Developing the Loop	30
One-half Loop to Inverted	30
One-half Inside Loop from Inverted	30
One-half Cuban 8	31
Split S	31
Immelmann	32
Square Loop	32
English Bunt	33
Outside Loop	33
Cuban 8 (inside-outside)	34
Cuban 8 (outside-inside)	35
Developing the Hammerhead	36
Inverted Hammerhead	36
Some Additional Maneuvers	37
LESSON EIGHT: AEROBATICS IN SEQUENCE	39
The Aresti Card	39
Basic Aresti Symbols	39
Constructing an Aresti Card	40
Aerobatic Competition	40
THE SIERRA STUNT FLYER COMPETITION	43
INDEX	45
WARRANTY	47

INTRODUCTION

Welcome to the Sierra Stunt Flyer flight school.

With Stunt Flyer, you will learn to negotiate your stunt plane through aerobatic maneuvers like those performed by stunt pilots in international competition.

Follow the lessons in this manual to familiarize yourself with your stunt plane. Just as if you were really learning to fly, your first four lessons will be on the ground. You will learn how your plane is built and what keeps it aloft. You will learn to control the plane in various positions, and to monitor your location in the sky. Finally, your aerobatics instructor will take you up and talk you through the four basic aerobatic maneuvers and, when you're ready, through some of the more advanced ones.

After you've trained for some time, and have achieved a minimum level of competency on over 20 different maneuvers, you will be invited to enter the Sierra Stunt Flyer Competition. It's your opportunity to prove how good a stunt pilot you really are. Not for the faint-hearted, the Stunt Flyer Competition is truly a death-defying challenge in precision aerobatics.

A NOTE FROM THE DESIGNERS

We have attempted to duplicate precision aerobatics in the Stunt Flyer program. Professional stunt pilots have evaluated it to ensure that it realistically simulates a real-life stunt plane. There have been just two slight adjustments, to simplify the experience for you.

First, because it complicates already difficult maneuvers, the torque effect has not been included in Stunt Flyer.

Torque is the force caused by the rotation of the propeller. It causes the plane to want to yaw (rotate in the horizontal plane) to the left. Pilots correct for this by adding a little extra rudder to each maneuver.

Secondly, although stunt planes usually allow at least three views (front, both sides, and sometimes out the top of an open cockpit plane), the complexity of the Stunt Flyer program made more than one view (the front) impossible. Therefore, the few maneuvers that require more than a forward view (such as a vertical climbing roll) are difficult to perform accurately using Stunt Flyer.

AEROBATICS: YESTERDAY AND TODAY

Centuries before the Wright brothers made that first, historic flight, men watched the birds in the sky and envied their freedom. The shaky flight at Kitty Hawk was a long way from the effortless soaring of the birds, though, and aviators redoubled their efforts.

The Origins of Aerobatics

Soon, better aircraft with more reliable engines began to appear. The pilots of these machines vied with one another in flying demonstrations, to prove the superiority of their crafts. It was out of such meetings that the sport of aerobatics was born.

World War I brought rapid advances in aircraft design. It was soon discovered that the pilot with more power and maneuverability generally emerged victorious in air combat. Pilots who stretched their machines to the limit were the most glamorous of men, famed for their exploits by Allies and Axis powers alike (curse you, Red Baron!)

In peacetime, aerobatics soared to new heights of accomplishment as pilots (both men *and* women) strained to equal the grace and skill of those much-envied birds. Flying circuses sprang up, startling audiences with death-defying (and sometimes tragic) displays of daring. Stunt flying, or barnstorming, as this form of entertainment came to be known, developed a reputation early on for recklessness and stupidity as pilots attempted seemingly impossible maneuvers before increasingly jaded audiences.

Aerobatics Today

In its pure form, aerobatics is a sort of aerial ballet. The maneuvers possible are endless, ranging from simple loops and rolls to combinations that truly demonstrate the oneness of pilot and machine.

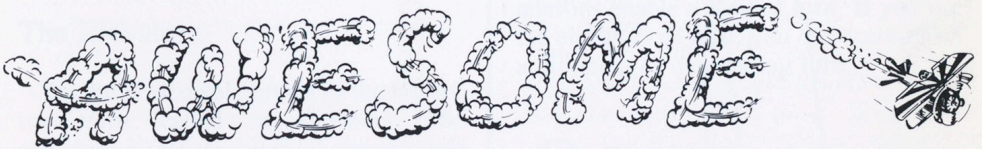

LESSON ONE: GETTING TO KNOW YOUR PLANE

Airplane Construction

Almost any airplane is capable of basic aerobatic maneuvers -- even a 747! There are, however, planes that are constructed to be especially maneuverable, to fly equally easily both upright and inverted, and to better withstand the stresses resulting from many maneuvers. Your plane, a Pitts Special, is the most maneuverable of all stunt planes.

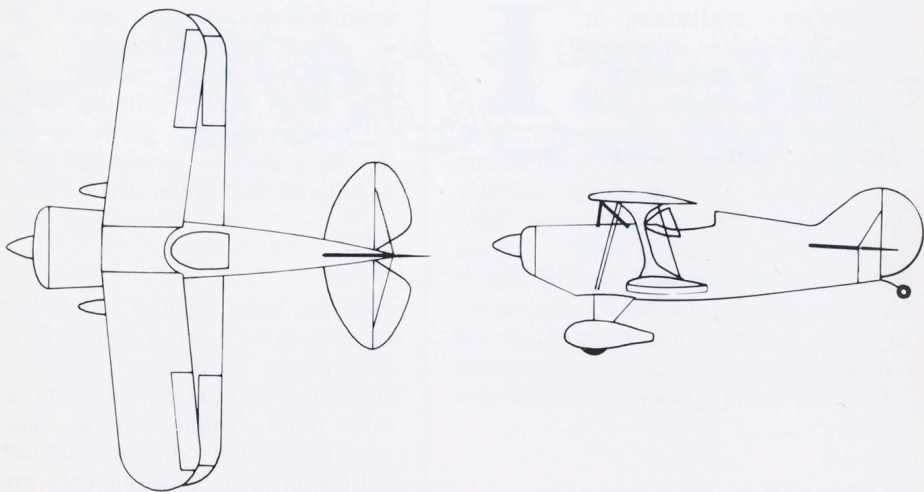

THE CONTROLS

To maneuver your plane, you will need to understand and master the basic controls.

Throttle

The throttle in an airplane functions in the same manner as the gas pedal of a car. It controls the flow of fuel to the engine, which affects the number of propeller revolutions per minute (RPM's). This, in turn, affects the speed of the airplane. In a real plane, the throttle is usually a lever located at your side.

The Elevators

On the horizontal portion of the tail are two flaps, called the elevators. The elevators affect the pitch of the airplane (whether the nose is pointed up, down, or somewhere in between.)

The elevators are also operated with the control stick on the floor of the plane (it looks somewhat like the gear shift in a standard automobile). Pushing forward on the stick causes the plane to point down, and pulling back causes the plane to point up. A short elevator input (then returning the controls to neutral) will cause the plane to ascend or descend. A longer elevator input will cause the plane to loop up or down.

The Ailerons

The flaps on the wings are called ailerons. When one aileron moves up the other moves down, causing one wing to drop and the other to lift.

The ailerons are controlled with the control stick. Pushing left on the stick causes the plane to roll left, and pushing right causes the plane to roll right. When used together with the rudder, the ailerons enable a banked turn. If you use the elevators as well, you can accomplish a climbing or descending turn.

The Rudder

The flap on the vertical portion of the tail is called the rudder. By itself, it is used in making turns. Together with the ailerons, it enables banked turns.

The rudder is controlled by two pedals on the floor of the cockpit. Pushing on the left pedal causes the nose to angle left. Pushing on the right pedal causes the nose to angle right.

LESSON TWO: PRINCIPLES OF AERODYNAMICS

Lift

Lift is caused, in part, when a wing is angled in relation to the airflow (relative wind). This is easily demonstrated by viewing a cross section of an airplane wing.

In upright level flight, the body of the plane is exactly horizontal, and the wings are angled slightly up in the front. The angle of attack is measured from the airflow to an imaginary chord running through the center of gravity of the wing (see illustration). As the plane moves forward, the airflow makes contact with each wing. The airflow separates, half flowing over the wing, and half flowing under. You can see that the air flowing over the top of the wing has farther to travel before it meets and

rejoins the other half of the airflow. Because the airflow over the top of the wing has farther to go than does the corresponding airflow below the wing, the airflow over the top of the wing must travel faster than the airflow beneath the wing. And because it is traveling faster than the airflow underneath the wing, the airflow on the top exerts less pressure downward than is being applied upward by the airflow underneath. Lift is produced -- enough to keep a heavy plane aloft in level flight.

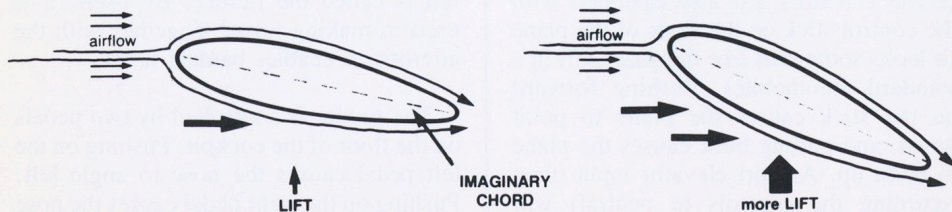

Lift vs. Weight and Thrust vs. Drag

The “Lift” that supports a wing counters the gravitational forces that would bring it down. The actual amount of lift needed to buoy a plane up is that which counteracts the gravitational pull (weight) and the drag caused when the plane thrusts forward.

As shown in the diagram, the amount of lift needed to offset gravity (we call this lift the “vertical lift”) combines with the amount of lift needed to offset drag (produced by the thrust of the engine) to form a right triangle. The hypotenuse, perpendicular to the wing’s center of gravity, expresses the amount of lift necessary to maintain the plane in level flight.

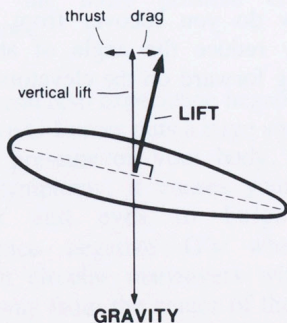

Now use the elevators to change the pitch of the plane (and with it the wing’s angle of attack). Since the “vertical lift” vector, which offsets weight, remains the same, and the angle between the vertical lift and lift vectors increases, the lift component (hypotenuse) will be longer. The “drag” vector is longer too. Therefore more thrust is needed to maintain lift for level flight as the nose of the plane is angled up.

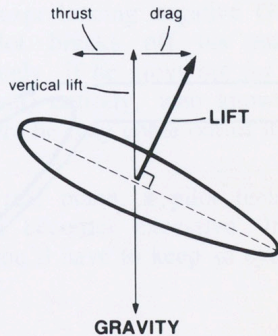

To ascend, you must increase the thrust of the engine beyond that needed to maintain level flight. The amount of excess thrust applied determines the climb rate of the aircraft.

The Stall

There is a limit to the amount of lift you can generate by increasing the angle of attack.

If you apply elevators without increasing thrust, your flight path will remain unchanged (the plane will want to loop, but won't have enough thrust). The resulting angle of attack is increased. Remember, angle of attack is measured between the flow of relative wind (which is in direct opposition to your flight path) and the imaginary chord that runs through the wing's center of gravity. When the angle of attack becomes too great, the plane will stall.

The picture illustrates what happens when a high angle of attack causes the wings to stall. The slow airflow over the top of the wing (remember, we are not generating enough thrust in relation to the angle of attack) becomes turbulent, and spills instead of flowing across the wing. The airflow rejoining at the edge of the wing is disturbed, causing forward momentum to decrease sharply. Lift is lost. If you don't recover, the plane will lose altitude.

How do you recover from a stall? Simply reduce the angle of attack by pushing forward on the elevators.

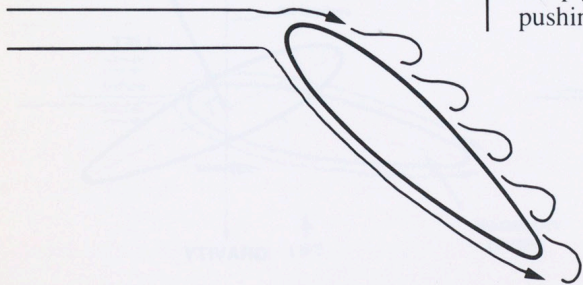

G-Force

When you perform aerobatic maneuvers, you put tremendous stress on yourself and your airplane. The airplane is built to handle it. You, however, must be careful.

When you are simply standing on the ground, the force acting on your body is one "G." That is, your body is held down to the earth by one times your gravitational pull, or weight. In an airplane, when three G's are acting on your body, it will feel as though you weigh three times as much as you really do. You experience positive G's when you perform circular maneuvers with your head toward the center of the circle. The tighter the circle (or the faster your speed), the more positive G's you experience.

You can also experience negative G's. Negative G-Forces puts a large amount of inward pressure on your body. Among other symptoms, it causes your blood vessels and eyes to bulge. You experience negative G's when you perform circular maneuvers with your head away from the center of the circle. The tighter, or faster the circle, the more negative G's you will "pull."

Most maneuvers will exert G-Forces on your body. You can stand a large amount of positive or negative G-Forces; but the greater the force, the less time your body will tolerate it. At the tolerance point, you will grey out (or even black out) for a few seconds. The more G-Forces your body absorbs, the longer the recovery time before all effects have disappeared.

When he starts to grey out (or red out if he's experiencing negative G's), the safe pilot breaks off his maneuver immediately. If he greys out (or worse, blacks out) entirely, who knows when and where he may come out of it?

In a real plane, a pilot feels when G-forces becomes excessive. In Stunt Flyer, you'll have to keep an eye on the G-meter.

The Three Axes of Movement

A plane may rotate around three axes. The first axis is the one that passes through the center of the plane from the nose to the tail. Rotation around this axis is called *roll*, and is accomplished with the *ailerons*.

The second axis passes through the center of the plane from side to side. Rotation around this axis is called *pitch*, and is accomplished with the *elevators*.

The third axis passes through the center of the plane in a vertical direction (in relation to the plane, not the ground). Rotation around this third axis is called *yaw*, and is accomplished with the *rudder*.

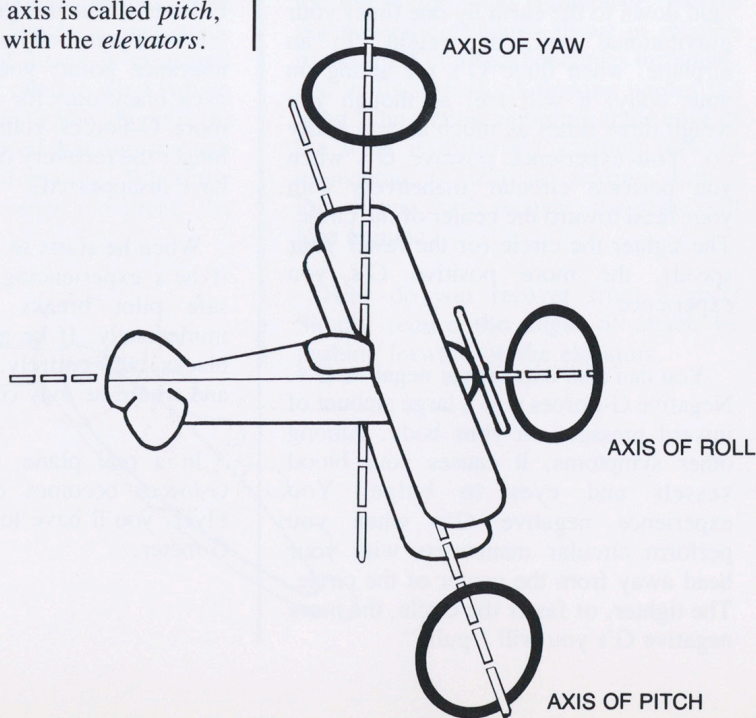

Roll

From the section on Lift you know that when an aileron angles down, the distance traveled by the air flow under the wing is decreased (and therefore slowed), and the distance traveled by the air flow over the wing is increased. This produces lift in that wing, and causes the other wing to drop. When an aileron angles up, the opposite result is obtained.

Applying left aileron raises the left aileron and lowers the right aileron, which makes the left wing drop and the right wing lift. Applying right aileron moves the right aileron up and the left aileron down, which makes the right wing drop and the left wing lift.

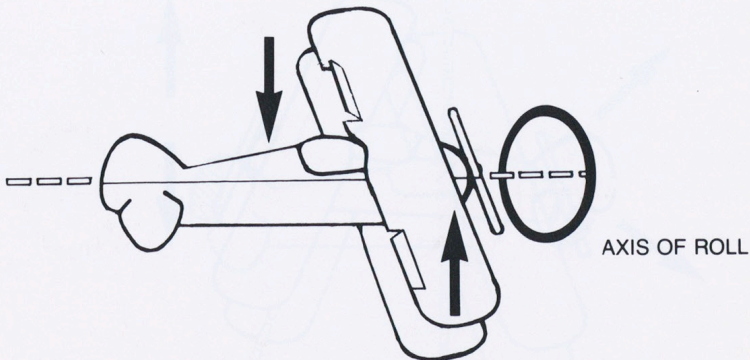

Pitch

When the elevators angle down, the distance traveled by the airflow under the tail is decreased (and therefore slowed), and the distance traveled by the airflow over the tail is increased. This produces lift in the tail section, and causes the nose to drop. When the elevators angle up, the opposite result is obtained.

Pushing forward on the control stick forces the elevators down, which causes the tail to lift and the nose of the plane to drop. Pulling back on the stick causes the elevators to come up, which makes the tail drop and the nose rise. When we talk about applying the elevators, sometimes we will say “apply forward pressure,” “apply back pressure,” or simply “push forward” or “pull back.”

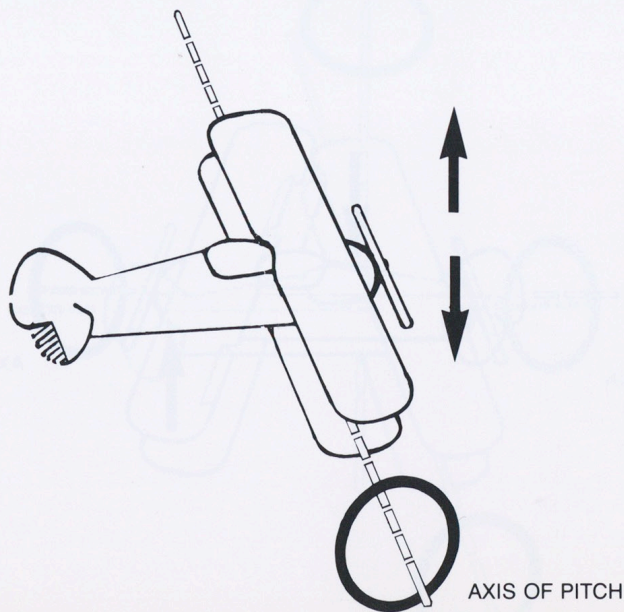

Yaw

The same principles which govern lift also apply to yaw. When the rudder is angled to the left, the distance traveled by the airflow is decreased on the left and increased on the right. The airflow on the right is traveling faster to go the same distance in the same amount of time, and applies less pressure. So, the airflow on the left exerts pressure on the tail, swinging it right (and of course, when the tail swings right, the nose swings left).

Applying left rudder causes the rudder to angle to the left, and the nose to angle to the left. Applying right rudder causes the rudder to angle right, and the nose to angle right.

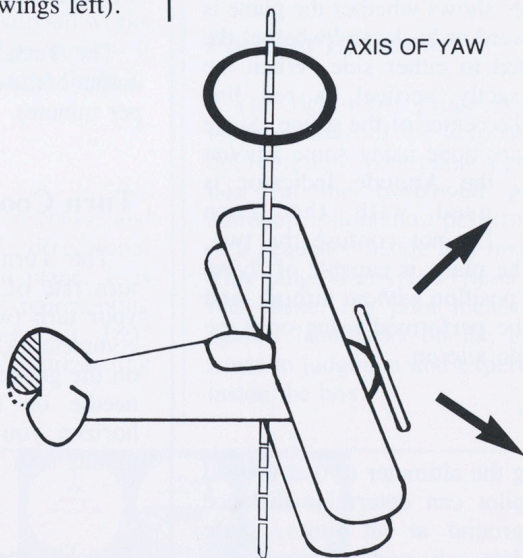

LESSON THREE: MONITORING PERFORMANCE

The Gauges

The gauges are used to monitor performance, and to fine tune it when necessary.

Air Speed Indicator

This gauge measures airspeed in miles per hour (MPH), in relation to the air, not the ground. You cannot control your plane beyond 250 mph.

Attitude Indicator

This gauge shows whether the plane is pitched forward or back, and whether the plane is tilted to either side. When the plane is exactly vertical, a red line appears in the center of the gauge. Since most turns are done using some amount of banking, the Attitude Indicator is frequently used with the Turn Coordinator. Do not confuse the two, however. The plane is capable of flying in a banked position *without* turning, and a turn *can* be performed using only the rudder and no aileron.

Altimeter

By setting the altimeter to 0 at ground level, the pilot can determine distance from the ground at all times. (Safe aerobatic pilots only perform maneuvers over level ground, so that their distance from ground level is constant in all areas of a sequence.)

Controls Indicator

The left-most gauge shows the positions of the rudder, ailerons and elevators. The bottom line represents the rudder position, and the cross shows the position of the ailerons and elevators.

Tachometer

The Tachometer measures the power output of the engine in RPMs (revolutions per minute).

Turn Coordinator

The Turn Coordinator measures the turn rate of your airplane. The sharper your turn (which governs how fast you complete it), the more slanted the needle on the gauge will be. If you position the needle on the first mark above the horizon, you should make a standard two-minute turn.

The Slipballs

The slipballs are located on the Turn Coordinator gauge. They help balance

rudder with ailerons to turn at a constant rate of speed (or keep from turning, if you don't want to). Use the lower slipball when flying upright, and the upper slipball when in inverted flight (in other words, the one nearest the ground). Watch the slipball as you would a level. When the bubble moves to the left, step on the left rudder to bring it to the center again. When the bubble moves to the right, step on the right rudder. As you adjust the rudder, the needle on the turn coordinator will also move, so you'll have to tune them together to keep your turn rate steady. (Note: the slipball works only in upright and inverted positions -- it is inoperative during knife edge flight.)

Heading Indicator

This gauge is a simple compass, and measures the N-S-E-W directional heading of the nose of the plane. It is measured in 360°, with 0° representing due North, 90° representing East, 180° representing South and 270° representing West.

Vertical Velocity Indicator

This meter shows the plane's rate of climb or descent in thousands of meters per minute.

G-meter

The G-Meter measures the amount of positive or negative G-Forces on your plane (and you). Keep a sharp eye on it as you fly, and you'll soon be able to determine which maneuvers produce more force and for how long.

Position Indicator

The right-most gauge is a miniature representation of the aerobatic box. The dot represents your plane's position in the box (in the horizontal plane only). Aerobatic pilots must perform maneuvers in a sequence inside this imaginary box. This gauge is unique to Stunt Flyer -- in a real plane, the pilot measures the box against landmarks on the ground, then trusts to judgment and experience to stay inside the box.

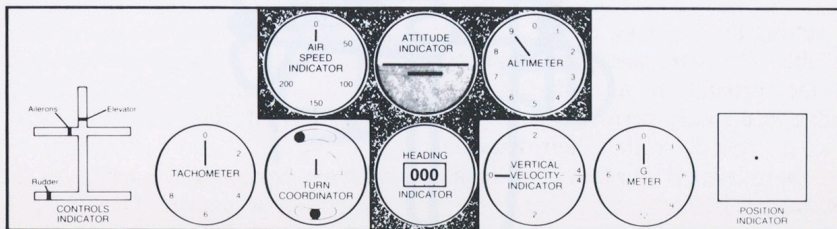

LESSON FOUR:

KNIFE-EDGE FLIGHT AND INVERTED FLIGHT

So far, when we have discussed the operation of the various controls we have always assumed that the plane was right-side-up, or level. But you won't be spending all your time flying upright.

Knife-Edge Flight

Let's see how things change when you fly with your wings exactly perpendicular to the ground (we call it "knife-edge flight").

The ailerons and elevators, which were horizontal in level flight, are now vertical. The rudder, which used to be vertical, is now horizontal. Since the change in the plane's attitude is on the roll axis, the ailerons are still used as they were in the upright flight position (to roll). But the

elevators now are used to control turns in the horizontal plane, instead of the rudder. The rudder is used to regulate movement in the vertical plane, in place of the elevators (you will need to apply some rudder to maintain lift in knife-edge flight for any period of time). Therefore, if you want to make a horizontal turn (no banking), you must use the elevators to yaw. If you want to change the pitch of the plane, use the rudder.

It may take awhile to get used to the changes in the control functions, but after you play with them awhile, you'll get the hang of it.

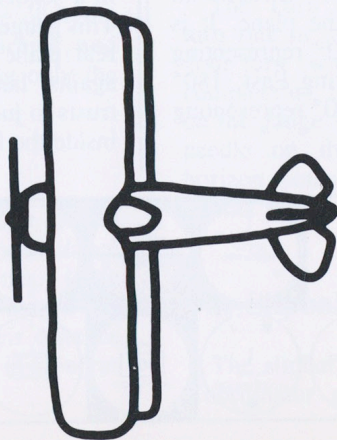

Inverted Flight

Once you are inverted beyond the point of either right knife-edge flight, or left knife-edge flight, the rudder and elevators begin to resume their normal functions. But inverted flight is tricky, too. You must either accept the fact that all the controls operate backwards from the way they did when you flew upright, or you must redefine your definition of “up” and “down,” “right” and “left.” Up and down are the hardest, because you must basically define your world in relation to the airplane, not the ground!

For example, when you pull back on the stick while in the upright position, the nose of the plane will tilt in the direction of your head -- that is, up. When you perform the same action when flying in an inverted position, the plane still tilts toward your head -- but in this case the plane now points down!

Think of the changes in the control functions in whichever way suits you better. But get used to it...you won't be able to do many maneuvers if you never get out of the upright position!

In-Between Attitudes

When you are flying at any angle other than exactly upright, exactly inverted, or knife-edge, the elevators and rudder perform in tandem. For instance, if you fly at a 45° angle, the rudder will provide some of the pitch control and the elevators will provide some also. They will also both control yaw. Move the plane a little closer to knife-edge, however, and the rudder will assume more control over pitch and the elevators less. Move back towards level flight and the elevators and rudder will regain more of their original functions.

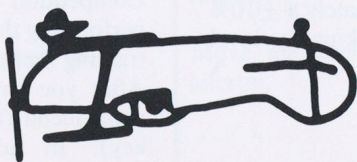

LESSON FIVE: START YOUR ENGINES

THE MENU

The Airshow

From the main menu, you may choose T)raining, or the A)irshow. If you go to the Airshow, you can view a S)quence of stunts, or you can view an I)ndividual stunt. If you choose to see an Individual stunt, you can choose from among 20 maneuvers.

Aerobatic Training

If you choose T)raining, you will be able to fly F)reestyle, or to perform a S)pecific stunt. If you choose to perform a Specific stunt, you will be judged against a perfect performance of that stunt. Judging begins from the time you leave level flight (or inverted flight, if that's how the maneuver begins) and ends when you resume level flight (or inverted, if the maneuver is supposed to end that way) for more than one second. Stunt Flyer allows approximately a $\pm 10\%$ margin of error when checking for level flight.

Replay and Judging

After you perform a maneuver, you can return to the M)ain menu, T)ry again,

S)ore for replay later (up to four flights may be stored), or watch your stunt R)played and judged. After a score is given for the maneuver you performed last, you may S)ee your stunt again, W)atch an expert perform that same maneuver, try your N)ext stunt, or return to the M)ain menu.

Don't be discouraged if you don't immediately get high scores -- stunt flying is not a skill learned overnight. And frankly, occasionally the judges will be moody and will judge you accordingly.

The Competition

You will not be able to enter the competition until you have attained a score of at least 50% on any 15 of the 20 stunts listed in the training section. You would be well advised to master all 14 of the maneuvers in the compulsory Competition Sequence, then practice performing them sequentially in Freestyle training before trying the competition. After you have done this, return to the main menu (by pressing the appropriate key). In addition to A)irshow and T)raining, C)ompetition will now appear on your list of options.

COMPUTER CONTROLS

Keyboard Controls

You may use keyboard controls to fly your plane, or a combination of joystick and keyboard controls.

To neutralize (take off) control inputs, press the "center" key for the appropriate control.

Number keys control throttle	1 = cut power 2 = 1/8 power 3 = 2/8 power, etc. 9 = full power	Left or right hand operates elevators	T or U = Elevators forward G or H = Elevators center V or N = Elevators back
Left hand operates rudder	S = Rudder left D = Rudder center F = Rudder right	Right hand operates ailerons	J = Aileron left K = Aileron center L = Aileron right

Joystick Controls

You may use the joystick to control ailerons and elevators. You must still use the keyboard for rudder and throttle controls, to neutralize elevator, and to pause game or return to the main menu.

Move the joystick up to apply forward elevator pressure.

Move the joystick left to apply left aileron.

Move the joystick down to apply back elevator pressure.

Move the joystick right to apply right aileron.

Press the joystick button to center ailerons.

LESSON SIX: THE FOUR BASIC MANEUVERS

At last. Now for the fun!

An infinite number of aerobatic maneuvers are possible. But no matter how complex, each is a variation on one or more of the four basic maneuvers.

Each maneuver name is followed by a number, in parentheses. It represents the K-value, or difficulty factor, of the maneuver. The higher the number, the harder the maneuver.

Read the directions and diagrams for performing different maneuvers. Watch the experts at the Airshow. Then make your own paper airplane and try to perform each maneuver before you go up in the plane -- believe it or not, that's how real-life stunt pilots learn to visualize maneuvers in three dimensions!

Slow Roll (K10)

To roll right, first find a straight road on the ground below to help keep track of your direction. When you're ready, apply

right aileron. When you want to stop the roll, neutralize ailerons. Be careful to maintain the level pitch and a constant heading through the entire maneuver.

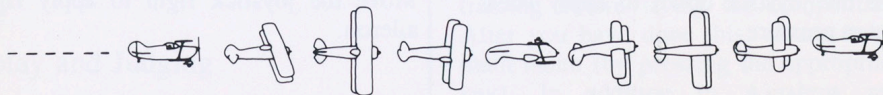

The Inside Loop (K12)

Again, position your plane along a road to help monitor the loop. To begin the loop, apply back pressure (pull the control stick back). Increase power, as needed, to keep the loop round. As you approach the top of the loop, apply forward pressure. As you descend the second half of the loop, reduce throttle

and apply an increasing amount of back pressure to exit the finished loop in level flight.

Sound simple? Well, it's roughly comparable to drawing a perfect circle freehand. Simple -- yet very difficult. Perfecting the loop requires many hours of practice, much patience, and great precision.

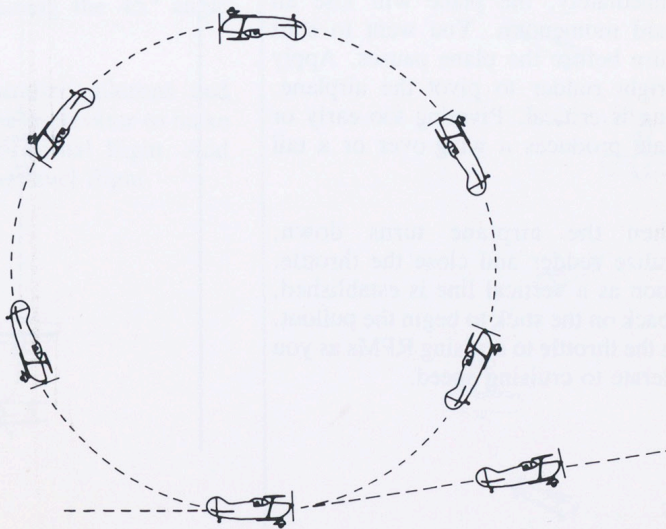

The Hammerhead (K20)

This maneuver (sometimes referred to as the Stall Turn) requires precision and a keen sense of timing. To begin, apply back pressure. Keep climbing until your wings are perpendicular to the horizon (remember the red bar on the attitude indicator). The bar in the attitude indicator will be centered when you are perfectly vertical. Then neutralize elevators to keep the plane from continuing to loop over.

Immediately, the plane will lose all forward momentum. You want to start the turn before the plane pauses. Apply full right rudder to pivot the airplane. Timing is critical. Pivoting too early or too late produces a wing-over or a tail slide.

When the airplane turns down, neutralize rudder and close the throttle. As soon as a vertical line is established, pull back on the stick to begin the pullout. Open the throttle to cruising RPMs as you decelerate to cruising speed.

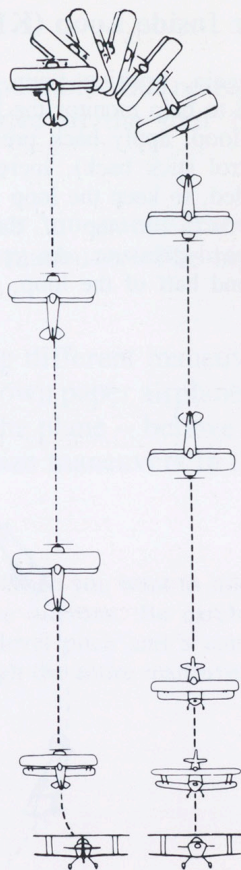

The Spin (K10)

Since it is quite likely that the spin will be encountered accidentally in aerobatics, it is a good idea to master this maneuver (especially the pullout). Also called the stall spin, the basic spin begins when you slow down to minimum speed (around 50 mph), then apply back pressure changing the angle of attack until the plane stalls. The nose will fall through the horizon. Neutralize elevators as the plane reaches a 45° angle with the ground. Apply left rudder and aileron to rotate the plane twice, maintaining the 45° angle throughout.

To recover, neutralize ailerons and rudder, then apply back elevator to make a clean exit into horizontal flight. Add power as you resume level flight.

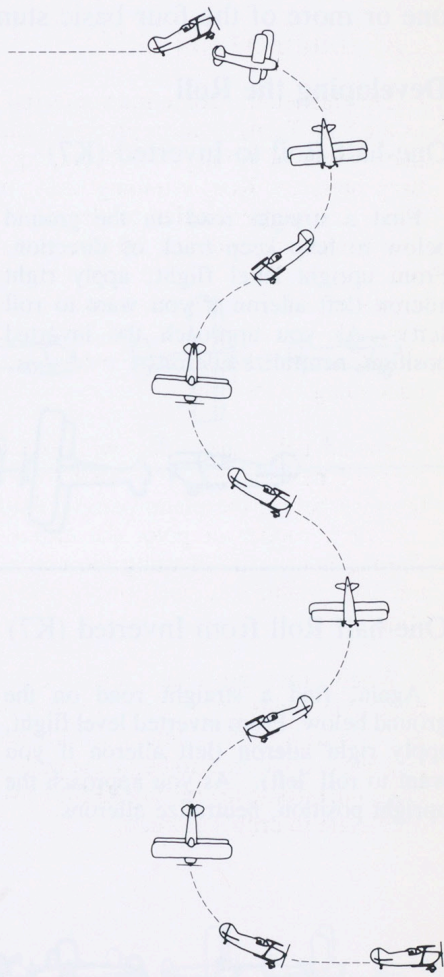

LESSON SEVEN

DEVELOPING THE BASICS

Thousands of aerobatic maneuvers are possible. Each is a variation on one or more of the four basic stunts: roll, loop, hammerhead and spin.

Developing the Roll

One-half Roll to Inverted (K7)

Find a straight road on the ground below to help keep track of direction. From upright level flight, apply right aileron (left aileron if you want to roll left). As you approach the inverted position, neutralize ailerons.

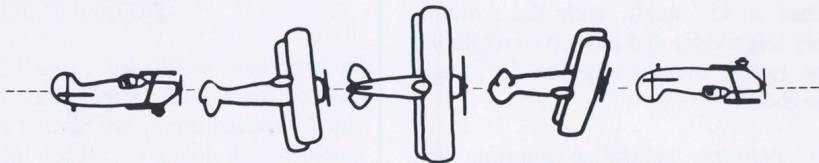

One-half Roll from Inverted (K7)

Again, find a straight road on the ground below. From inverted level flight, apply right aileron (left aileron if you want to roll left). As you approach the upright position, neutralize ailerons.

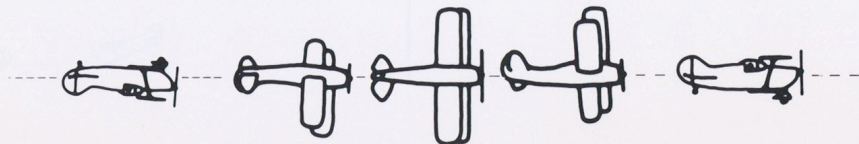

4-point Hesitation Roll (K11)

Apply right aileron to begin rolling. Briefly stop at the 1/4, 1/2 and 3/4 marks of this roll. Neutralize ailerons to stop. Apply the appropriate elevator or rudder controls to maintain level pitch and heading at each stop.

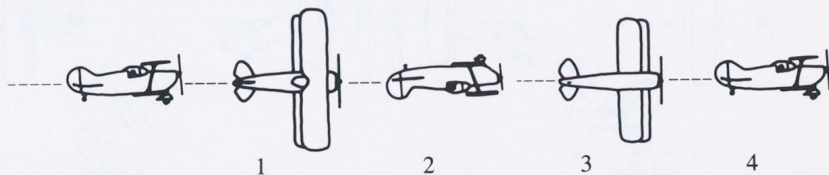

8-point Hesitation Roll (K12)

If you thought the 4-point hesitation roll was a challenge, wait 'til you try the 8-point! Besides the 90° stops, you now must also stop on each 45° angle. Use a combination of rudder and elevator to maintain level flight and heading in each position (see section on "In-Between Attitudes").

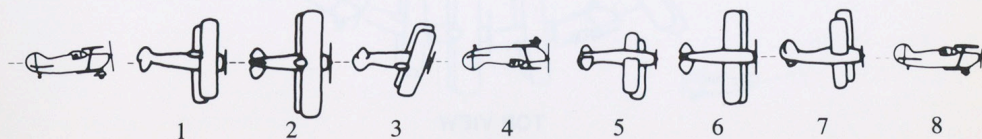

LESSON SEVEN

DEVELOPING THE BASES

360° Rolling Circle (Four Rolls to Outside) (K34)

To roll to the outside, apply the opposite aileron from the rudder you are using to make the turn. You won't want to attempt this maneuver until you are very experienced. Watch the expert at the airshow to see how it's done.

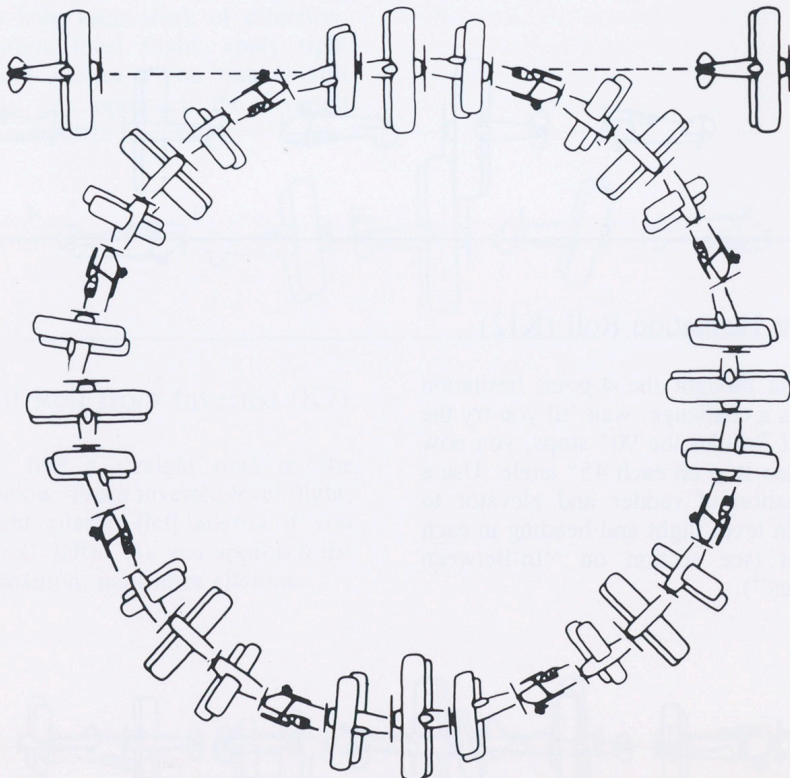

TOP VIEW

Developing the Loop

One-half Loop to Inverted (K8)

Position your plane along a road to help monitor the loop. To begin the loop, apply back pressure (pull the stick back). Increase power as needed to keep the loop round. As you approach the top of the loop, neutralize elevators to level out in inverted flight.

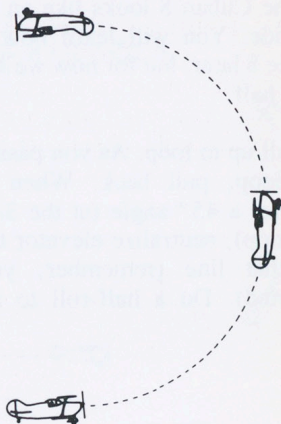

One-half Inside Loop from Inverted (K8)

Position your plane along a road to help monitor the 1/2 loop. From inverted flight, apply back pressure (pull the stick back). Decrease power as needed to keep the loop round. Neutralize elevators as you reach level upright flight.

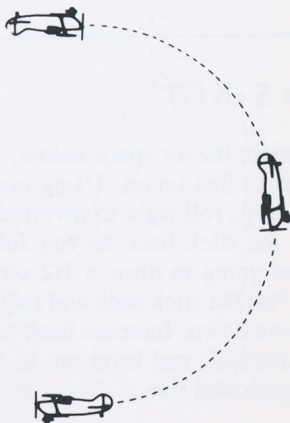

One-half Cuban 8 (K16)

The Cuban 8 looks like an 8 lying on its side. You will learn how to do the whole 8 later, but for now we'll start with only half.

Pull up to loop. As you pass the top of the loop, pull back. When the plane reaches a 45° angle (at the 3/4 point of the loop), neutralize elevator to continue on that line (remember, you're still inverted). Do a half-roll to an upright

position, using the right aileron. Neutralize ailerons to stop the roll. Apply back pressure as you come upright. Pull back further to bring the plane back to horizontal flight.

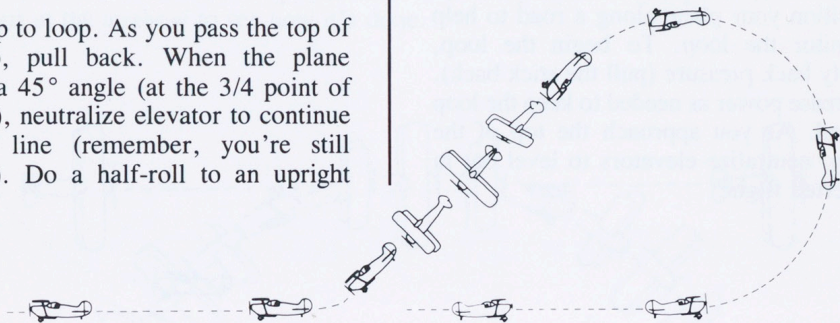

Split S (K17)

Inspect the air space below, and select a road to line up on. Using normal slow roll entry, roll right to inverted position. Ease the stick back as you finish. Now you're going to draw a 1/2 circle in the sky. Pull the stick back and reduce power to curve down. Increase back pressure as you descend, and level out as you reach the horizontal line.

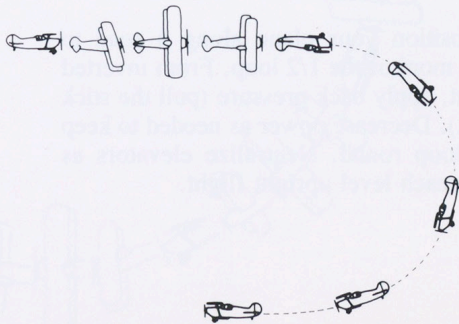

Immelmann (K17)

To perform the Immelmann, first apply back pressure to begin looping. Push the stick forward to finish the loop at the top. Then roll out from the inverted position by applying right aileron. Neutralize ailerons to stop the roll in upright flight.

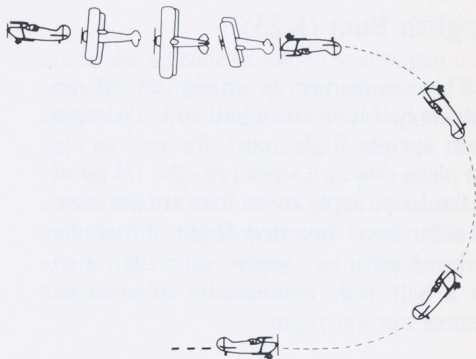

Square Loop (K18)

A very high entry speed is required for this maneuver. To execute the square loop, establish a tight horizontal line, then pull firmly back on the stick for a tight 90° corner. Neutralize elevators to keep the vertical line straight, then pull back again to make another tight 90° corner. Neutralize elevators again to maintain horizontal flight in the inverted position. Apply back pressure again to make the third corner, and reduce throttle to keep the maneuver regular. At the bottom of the last side of the square, apply back pressure to make the last sharp turn, then add throttle to resume cruising speed. The maneuver ends when you resume horizontal flight.

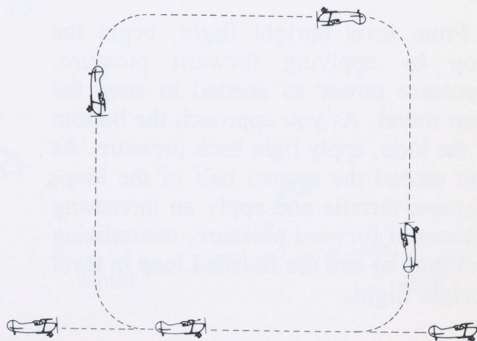

English Bunt (K23)

This maneuver is made up of an outside half loop and a half roll. To begin from upright flight, push forward to arc the plane down. As you pass the 1/4 point of the loop, apply more forward pressure to enter level inverted flight. From the inverted position, apply right aileron to do a half roll, neutralizing ailerons to resume upright flight.

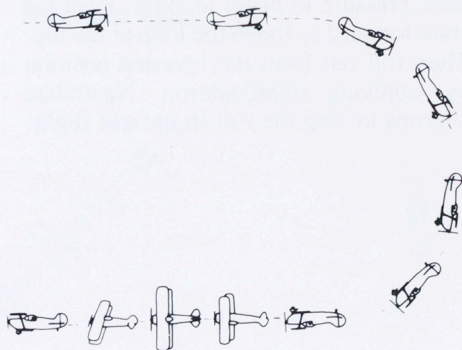

Outside Loop (K24)

From level upright flight, begin the loop by applying forward pressure. Decrease power as needed to keep the loop round. As you approach the bottom of the loop, apply light back pressure. As you ascend the second half of the loop, increase throttle and apply an increasing amount of forward pressure, neutralizing elevators to exit the finished loop in level upright flight.

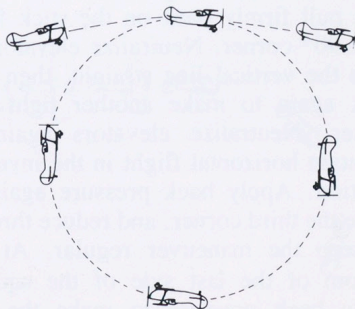

Cuban 8 (inside-outside) (K28)

From level upright flight, pull up in a loop. As you approach the top of the loop, reduce throttle to make the loop round. When the plane reaches a 45° angle (at the $3/4$ point of the loop), neutralize elevators to continue on that line (remember, you're still inverted). To begin the second loop, push forward to

arc at the altitude at which you began the maneuver. Increase power as needed to keep the curve round. As you approach the top of the figure, ease off the elevators. Apply forward pressure to curve down, and neutralize elevators to exit the finished loop at a 45° angle. Then apply back pressure to finish the maneuver on a horizontal line.

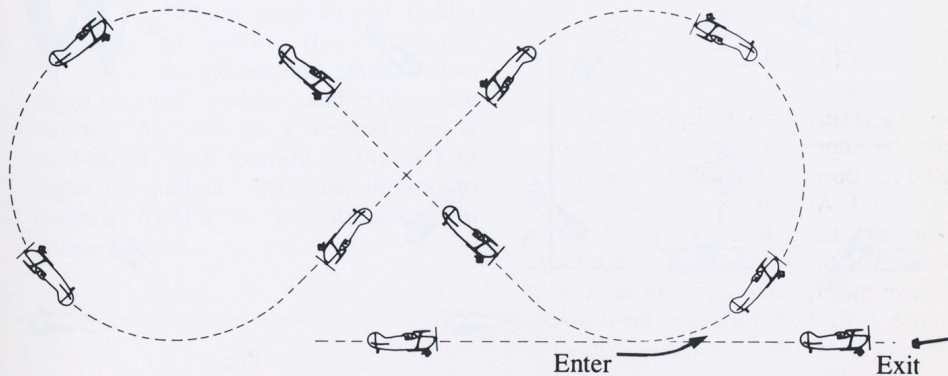

Cuban 8 (outside-inside) (K34)

From the inverted position, push forward to begin the looping. Increase power as needed to keep the curve round. As you approach the top of the figure, apply back pressure. When the plane reaches a 45° angle (at the $3/4$ point of the loop), pull back further to continue on that line (remember, you're upright

now). When you are at your beginning altitude, pull back to begin the second loop. Increase power as needed to keep the curve round. As you approach the top of the figure, apply forward pressure. When the plane reaches the 45° angle (at the $3/4$ point of the loop), neutralize elevators to continue on that line (you're inverted now). When you are again level with your beginning altitude, pull back to exit the maneuver in inverted flight.

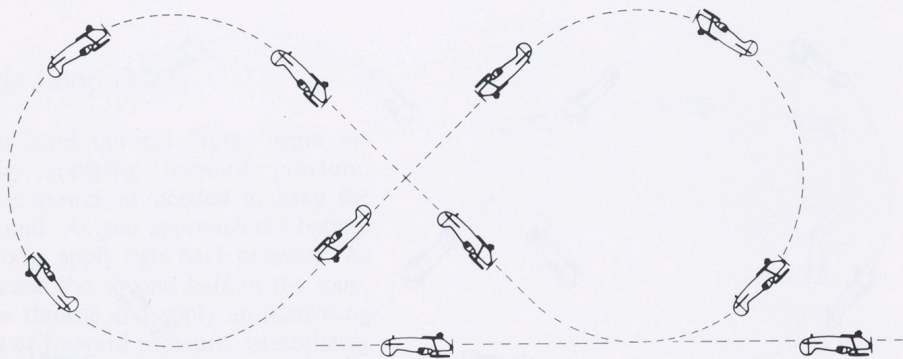

Developing the Hammerhead

Inverted Hammerhead (K27)

From the inverted position, make sure the wings are level; except for the bar on the attitude indicator, this is the last reference point you'll have until you start the second half of the maneuver.

Keep climbing until the wings are perpendicular to the horizon (the red bar on the attitude indicator will be centered). Then neutralize elevators to keep the plane from continuing to loop over.

When the plane slows to about 50 mph, apply full left rudder to pivot the airplane. As the airplane starts to turn down, center rudder and close the throttle. As soon as a vertical line is established, push forward on the stick to begin the pullout. Open the throttle to cruising RPM's as you decelerate to cruising speed.

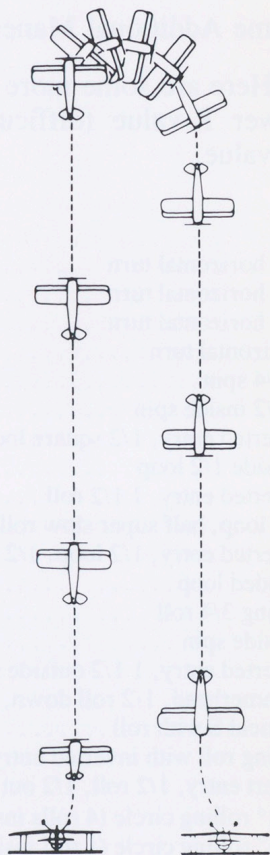

Some Additional Maneuvers

Here are some more maneuvers for you to practice. Try the ones with lower K-value (difficulty factor), then work up to ones with higher K-value.

	K-value
1/4 horizontal turn	1
1/2 horizontal turn	2
3/4 horizontal turn	3
horizontal turn	4
1 1/4 spin	11
1 1/2 inside spin	12
inverted entry, 1/2 square loop	12
outside 1/2 loop	14
inverted entry, 1 1/2 roll	14
1/2 loop, half super slow roll	16
inverted entry, 1/2 loop, 1/2 roll out	21
8-sided loop	22
diving 3/4 roll	23
outside spin	24
inverted entry, 1 1/2 outside spin	25
hammerhead, 1/2 roll down, inv exit	25
vertical S with roll	26
diving roll with inverted entry	26
invert entry, 1/2 roll, 1/2 out loop	27
360° rolling circle (4 rolls inside)	32
360° rolling circle (1 roll inside)	40
360° rolling circle (1 roll outside)	42

NOTES

LESSON EIGHT: AEROBATICS IN SEQUENCE

Once you have mastered a few maneuvers, you will want to put them together in sequence. The following are some examples of sequences that you can try.

When you are performing a sequence of maneuvers, it is important to maintain a consistent rhythm and timing. This will help you to execute the maneuvers smoothly and safely. Start with a simple sequence, such as a roll followed by a climb, and gradually increase the complexity as you become more comfortable. Always remember to maintain proper posture and control throughout the entire sequence.

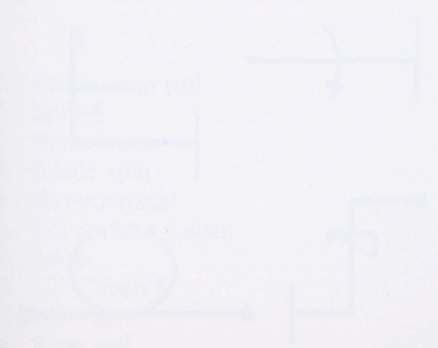

When you are performing a sequence of maneuvers, it is important to maintain a consistent rhythm and timing. This will help you to execute the maneuvers smoothly and safely. Start with a simple sequence, such as a roll followed by a climb, and gradually increase the complexity as you become more comfortable. Always remember to maintain proper posture and control throughout the entire sequence.

Once you have mastered a few maneuvers, you will want to put them together in sequence. The following are some examples of sequences that you can try.

LESSON EIGHT: AEROBATICS IN SEQUENCE

Once you have mastered a few maneuvers, you will want to put them together in sequences, like all serious stunt pilots.

The Aresti Card

When you design a sequence, you could just write out the maneuvers in order of performance, and memorize them. But what happens if you forget part of your carefully planned sequence once you're up in the air? At best, it's irritating... at worst, it's dangerous! An experienced stunt pilot doesn't trust to memory -- instead, he or she constructs an Aresti Card.

An Aresti Card acts as a sort of "crib sheet" during aerobatic maneuvers. On the card is a group of symbols, each representing one maneuver in the sequence, in the order in which they are performed. It is attached securely to the control panel of the cockpit by a metal clip.

Basic Aresti Symbols

Each of the thousands of maneuvers possible is represented by an Aresti symbol (named for the man who invented the shorthand, and compiled the Aresti

Dictionary cataloging them). Just as each maneuver is made up of one or more of the basic four maneuvers, the Aresti symbol for each is a combination of simple lines and curves. Below are pictures of the basic four. The dot indicates the beginning of each maneuver. An arrow crossing the line represents a roll, a barb at the top of a vertical line represents a hammerhead, and a triangle with a flag on the corner represents a spin (the loop is self-explanatory). Notice that upright flight is shown as a solid line, while inverted flight is shown as a broken line. Knife-edge flight is a dotted broken line.

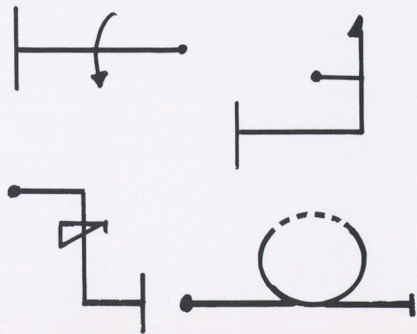

Constructing an Aresti Card

When designing a sequence, remember that each maneuver should lead into the next. Perform a maneuver that uses height, then make the next maneuver one that will regain that height. Or, if a maneuver costs you airspeed, gain back that airspeed with the next maneuver in your carefully planned sequence.

Here is an example of a carefully planned sequence. It is well balanced, containing a variety of different maneuvers. See if you can translate these maneuvers into Aresti symbols on an Aresti card. If you need a hint, turn the page to look at the finished Aresti card.

1. Inside snap roll
2. Split-S
3. Immelmann
4. Inside spin
5. Hammerhead
6. 1/2 reverse Cuban
7. Loop
8. 1/2 Cuban 8
9. 270° turn
10. Slow roll

Aerobatic Competition

Competitive Aerobatics, sponsored by the International Aerobatics Club, has become more popular each year. To cover all levels of ability, the contests are divided into four categories: Sportsman, Intermediate, Advanced and Unlimited. Pilots in the Sportsman class fly only a known compulsory sequence of maneuvers (shown on page 42). Intermediate pilots fly both a compulsory sequence and a free style sequence of their own design. Advanced and Unlimited contestants fly a known compulsory group which they have practiced, an unknown sequence of maneuvers which are issued the night before they are to perform them without practice, and a sequence of their own design. In addition, Unlimited pilots present a four-minute air show routine.

All maneuvers are performed inside the "box." In Stunt Flyer, this is an area of approximately 2,000 meters square, and 1,400 meters high. The top of the box is at 1,500 meters above the ground, and the bottom is 100 meters from the ground. Competitors are judged by the quality of performance, smoothness of transition from maneuver to maneuver, and maximum use of the area inside the box (without actually leaving it).

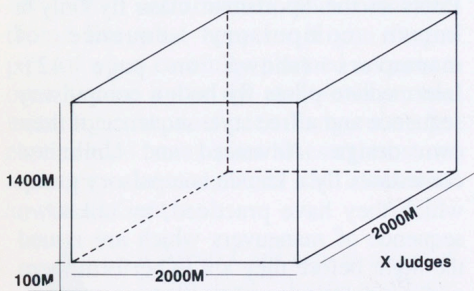

Performing individual maneuvers is not as difficult as performing those same maneuvers in a sequence. You have to stay in the box the whole time, executing each maneuver to give working room for the next. And you have to maintain your standard of performance for a much longer period. Before trying the Sierra Stunt Flyer Competition, practice flying (in freestyle training) the 1985 Sportsman Sequence pictured opposite. Practicing this sequence will help you prepare for the more grueling Stunt Flyer Competition.

When you've mastered the Sportsman Sequence, make up a few sequences of your own. Try to use a lot of variety in your selections. Remember that when you enter the Sierra Stunt Flyer Competition you'll need to fly your own freestyle sequence, lasting no more than 60 seconds.

Finally, when you think you're up to it, practice the compulsory Stunt Flyer Competition sequence. Don't think you're cheating by getting good and ready. Aerobatic pilots practice for months before entering international competition -- so should you!

Proposed 1985 Sportsman Sequence

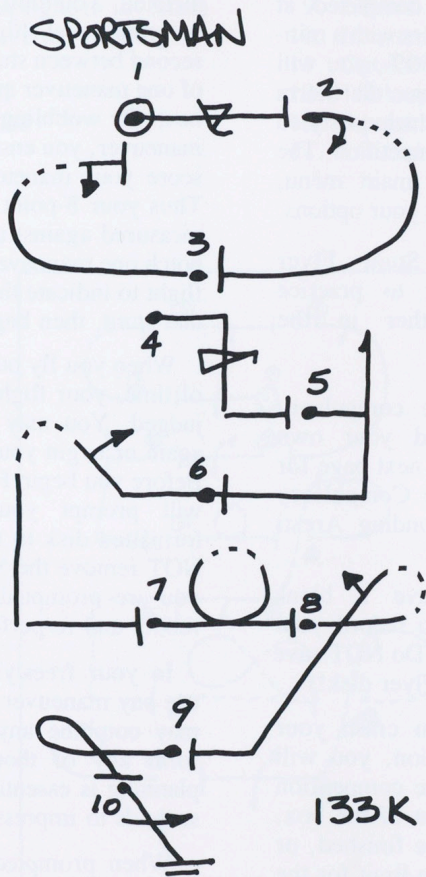

THE SIERRA STUNT FLYER COMPETITION

Once you have completed at least 15 maneuvers with a minimum score of 50%, you will be eligible to enter the Sierra Stunt Flyer Competition which is styled after a real-life aerobatic competition. The next time you go to the main menu, Competition will be among your options.

Before entering the Stunt Flyer Competition, you'll want to practice putting maneuvers together in the freestyle training section.

You will be flying the compulsory Stunt Flyer sequence and your own freestyle sequence. See the next page for order of maneuvers in the Compulsory sequence and the corresponding Aresti card.

Be sure that you have a blank formatted disk available to record your score for the competition. (Do NOT save your score on your Stunt Flyer disk!)

Be very careful! If you crash your plane during the competition, you will have to reboot. To exit the competition gracefully you must fly out of the box, which signifies that you are finished, or exceed the five-minute time limit for the sequence.

The judges will score you on the 14 specific maneuvers, in the exact order

dictated. You must resume level flight (or inverted level flight) for at least one second between stunts, to indicate the end of one maneuver and the beginning of the next. By wobbling wildly, or repeating a maneuver, you ensure that the judges will score your maneuvers out of sequence. Thus your 8-point hesitation roll will be measured against a half Cuban 8. If you botch one maneuver, simply resume level flight to indicate that you're through with that stunt, then begin the next.

When you fly out of the box or run out of time, your flight will be replayed and judged. You may then see your flight again or begin your Freestyle sequence. Before you begin Freestyle, the computer will prompt you to insert a blank formatted disk to record your score. Do NOT remove the Stunt Flyer disk before you are prompted, or you will have to reboot and re-perform your sequence.

In your freestyle sequence, you may use any maneuver in this manual, or you may combine any of the basic four to form any of thousands more. Careful planning is essential -- you have only 60 seconds to impress the judges.

When prompted, reinsert the scoring disk to record your freestyle performance.

Stunt Flyer Competition Compulsory Sequence

5 minute time limit

1. Slow roll
2. 1/2 loop (upright to inverted)
3. 1/2 roll (inverted to upright)
4. Split-S
5. 4-point roll
6. Hammerhead
7. Loop
8. Immelman
9. 1/2 roll (upright to inverted)
10. Inverted hammerhead
11. Outside-inside Cuban 8
12. 1/2 loop
13. 8-point roll
14. 1/2 Cuban 8

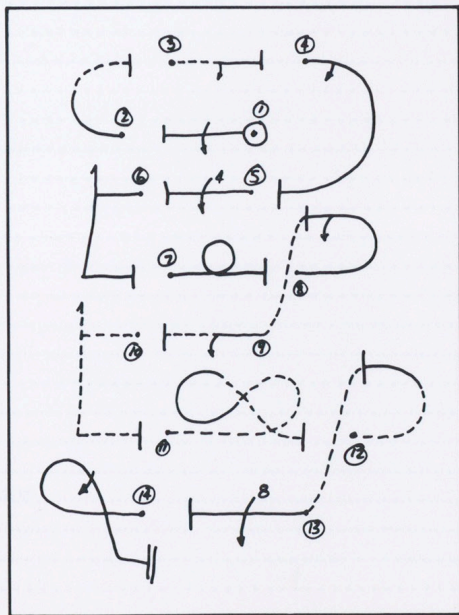

INDEX

aerobatics	5, 6, 37-44
ailerons	13, 14, 19
air speed indicator	17, 18
airflow	9-11
airplane construction	7
airshow	21, 23
altimeter	17
angle of attack	10-11
Aresti card	39, 40, 42, 44
Aresti symbols	39-40
attitude indicator	17, 18
back pressure	15
box	17, 41-43
competition	21, 40-44
controls	8
controls indicator	17, 18
Cuban 8	31, 34-35
drag	10
elevators	8, 10, 11, 13, 15
English bunt	33
forward pressure	15
gauges	17, 18
G-force	12
G-meter	12, 17-18
hammerhead	25, 27, 36
heading indicator	18
hesitation roll	28
Immelmann	32
inverted flight	20
joystick controls	22
judging	21, 41, 43

K-value	23, 37
keyboard controls	22
knife-edge flight	19, 20
lift	9-11
loop	24, 30-35
menus	21, 43
pitch	13, 15
Pitts Special	7
position indicator	17, 18
replay	21, 43
roll	13, 14, 19, 23, 27-29, 31-33
rolling circle	29, 37
rudder	8, 13, 16, 19, 20
slipball	18
slow roll	23
spin	26
split-S	31
Sportsman sequence	42
square loop	32
stall	11
tachometer	18
throttle	8, 22
thrust	10, 11
torque	4
turn coordinator	18
turns	8
vertical lift	9, 10
vertical velocity indicator	18
weight	10
yaw	13, 16

WARRANTY NOTICE

Sierra On-Line, Inc. wants your continued business. If you fill out the enclosed product registration card and return it to us (we have already paid the postage), you are covered by our warranty. If your software should fail within 90 days, return it to your dealer or directly to us, and we will replace it free. After 90 days, enclose \$5 and return the software directly to us. Sorry, without the registration card you are not covered by the warranty.

Sierra On-Line, Inc., P.O. Box 485, Coarsegold, CA 93614

WARNING

Unauthorized copying of this software and the documentation may be a violation of Federal Criminal Laws (Title 17 USC Section 506). Violation may carry a fine of \$25,000 or imprisonment for not more than one year for a first offense. Sierra On-Line, Inc. may have remedies under Federal Civil Laws (Title 17 USC Section 501) for unauthorized and unlawful copying of their copyrighted material.

Sierra and Stunt Flyer are trademarks of Sierra On-Line, Inc. © 1985 Sierra On-Line, Inc. All rights reserved.



SIERRA™

SIERRA ON-LINE, INC. • COARSEGOLD, CA 93614 • (209) 683-6858