

# Mouser

Entertainment Series



**IBM**

Software  
for IBM Personal  
Computer

Use your quick reflexes to help  
the farmer rid his house of mice.

## LIMITED WARRANTY

International Business Machines Corporation warrants this IBM Personal Computer Product including the medium upon which a copyrighted Program is stored to be in good working order for a period of one year from the date of purchase from IBM or an authorized IBM Personal Computer dealer. Should this Product fail to be in good working order at any time during this one-year warranty period, IBM will, at its option, repair or replace this Product at no additional charge except as set forth below. Repair parts and replacement Products will be furnished on an exchange basis and will be either reconditioned or new. All replaced parts and Products become the property of IBM. This limited warranty does not include service to repair damage to the Product resulting from accident, disaster, misuse, abuse, or non-IBM modification of the Product.

THE PROGRAM WHICH IS STORED ON A MEDIUM WITHIN THIS PRODUCT IS PROVIDED "AS IS" WITHOUT WARRANTY OF ANY KIND, EITHER EXPRESS OR IMPLIED, INCLUDING, BUT NOT LIMITED TO, THE IMPLIED WARRANTIES OF MERCHANTABILITY AND FITNESS FOR A PARTICULAR PURPOSE. THE ENTIRE RISK AS TO THE QUALITY AND PERFORMANCE OF THE PROGRAM IS WITH YOU. SHOULD THE PROGRAM PROVE DEFECTIVE, YOU (AND NOT IBM OR AN AUTHORIZED IBM PERSONAL COMPUTER DEALER) ASSUME THE ENTIRE COST OF CORRECTION. IBM does not warrant that the functions contained in the Program will meet your requirements or that the operation of the Program will be error free.

Limited Warranty service may be obtained by delivering the Product during the one-year warranty period to an authorized IBM Personal Computer dealer or IBM Service Center and providing proof of purchase date. If this Product is delivered by mail, you agree to insure the Product or assume the risk of loss or damage in transit, to prepay shipping charges to the warranty service location and to use the original shipping container or equivalent. Contact an authorized IBM Personal Computer dealer or write to IBM Personal Computer, Sales and Service, P.O. Box 1328-W, Boca Raton, Florida 33432, for further information.

ALL EXPRESS OR IMPLIED WARRANTIES FOR THIS PRODUCT, EXCEPT THE PROGRAM, INCLUDING THE WARRANTIES OF MERCHANTABILITY AND FITNESS FOR A PARTICULAR PURPOSE, ARE LIMITED IN DURATION TO A PERIOD OF ONE YEAR FROM THE DATE OF PURCHASE, AND NO WARRANTIES, WHETHER EXPRESS OR IMPLIED, WILL APPLY AFTER THIS PERIOD. SOME STATES DO NOT ALLOW LIMITATIONS ON HOW LONG AN IMPLIED WARRANTY LASTS, SO THE ABOVE LIMITATIONS MAY NOT APPLY TO YOU.

IF THIS PRODUCT, EXCEPT THE PROGRAM, IS NOT IN GOOD WORKING ORDER AS WARRANTED ABOVE, YOUR SOLE REMEDY SHALL BE REPAIR OR REPLACEMENT AS PROVIDED ABOVE. IN NO EVENT WILL IBM BE LIABLE TO YOU FOR ANY DAMAGES, INCLUDING ANY LOST PROFITS, LOST SAVINGS OR OTHER INCIDENTAL OR CONSEQUENTIAL DAMAGES ARISING OUT OF THE USE OF OR INABILITY TO USE SUCH PRODUCT, EVEN IF IBM OR AN AUTHORIZED IBM PERSONAL COMPUTER DEALER HAS BEEN ADVISED OF THE POSSIBILITY OF SUCH DAMAGES, OR FOR ANY CLAIM BY ANY OTHER PARTY.

SOME STATES DO NOT ALLOW THE EXCLUSION OR LIMITATION OF INCIDENTAL OR CONSEQUENTIAL DAMAGES OR IMPLIED WARRANTIES FOR CONSUMER PRODUCTS, SO THE ABOVE LIMITATIONS OR EXCLUSIONS MAY NOT APPLY TO YOU.

This warranty gives you specific legal rights, and you may also have other rights which may vary from state to state.

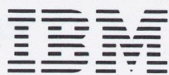

*Personal Computer  
Entertainment Series*

---

## Mouser

## **First Edition (May 1983)**

This product could include technical inaccuracies or typographical errors. Changes are periodically made to the information herein; these changes will be incorporated in new editions of the publication.

**The following paragraph applies only to the United States and Puerto Rico:** International Business Machines Corporation provides this manual "as is," without warranty of any kind, either expressed or implied, including, but not limited to, the particular purpose. IBM may make improvements and/or changes in the product(s) and/or the program(s) described in this manual at any time.

Products are not stocked at the address below. Requests for copies of this product and for technical information about the system should be made to your authorized IBM Personal Computer dealer.

A Reader's Comment Form is provided at the back of this publication. If the form has been removed, address comments to: IBM Corp., Personal Computer, P.O. Box 1328-C, Boca Raton, Florida 33432. IBM may use or distribute any of the information you supply in any way it believes appropriate without incurring any obligations whatever.

© Copyright International Business Machines Corporation 1983

# Mouser

## About the Game



Farmer Wheatbread discovered a large colony of mice on his farm. You must capture them before they take over, driving Farmer Wheatbread from his farmhouse.

To help you trap them he has installed a system of moving walls. You must push these walls to enclose and cage the mice. You must be careful that the mice don't catch you since you may lose a farmer! Don't be fooled... these mice are **DANGEROUS!** If you do fall victim to the mice, you have three more chances to assist the good farmer.

## Obstacles

The moving walls are set up in the farmer's nine-room farmhouse, and some of the rooms are dark ... the farmer forgot to pay his electric bill. So unless you picked up a flashlight in one of the rooms, you would not be able to find your way around in the dark rooms. Therefore you are advised to exit a dark room and not reenter it until you have the flashlight in your possession. The cheese is another obstacle. The cheese attracts mice, so you may want to set your trap around it. **CAUTION!** If the cheese is eaten by a female mouse, reproduction multiplies your problem. To help you, the female mouse will be a different color from the male mouse and the farmer.



# Getting Started

## How to Handle Cartridges

DO

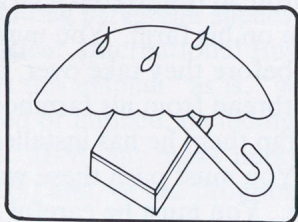

Keep them dry

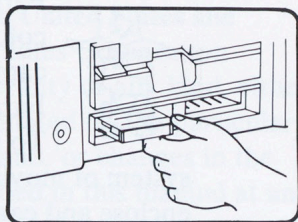

Insert them with the label side up

DON'T

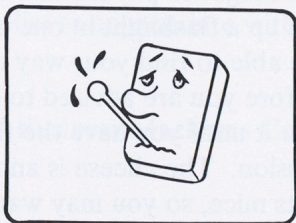

Don't get them too hot

## How to Insert and Remove a Cartridge

The cartridge slots on your IBM PCjr are shown below.

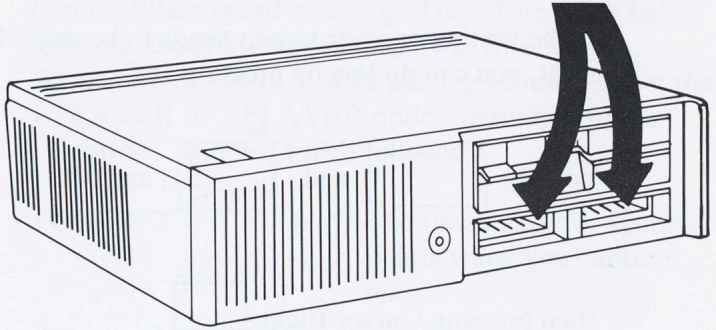

Switch on your IBM PCjr.

To insert your cartridge:

1. Hold your cartridge with the label side up so you can read it.
2. Firmly slide the cartridge into either slot until it snaps into place. If it doesn't snap into place, make sure the label side is up.

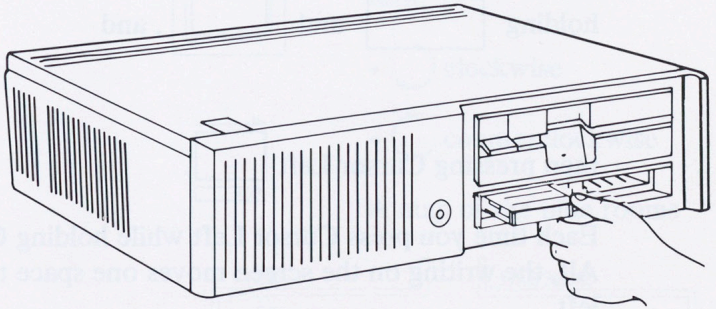

To remove your cartridge, slide it out of the slot.

You may insert or remove a cartridge at any time while the power is on. When you insert or remove a cartridge, your IBM PCjr behaves as if you just switched the power on.

# Screen Display

## How to Shift the Screen Display

If the writing on your screen needs to be moved to the right, you can do this by pressing and

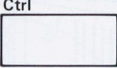
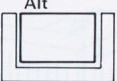
holding  and , and

then pressing Cursor Right .

Each time you press Cursor Right while holding Ctrl and Alt, the writing on the screen moves one space to the right.

If the writing on your screen needs to be moved to the left, you can do this by pressing and

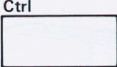
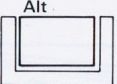
holding  and , and

then pressing Cursor Left .

Each time you press Cursor Left while holding Ctrl and Alt, the writing on the screen moves one space to the left.

When the writing on the screen is centered, release all three keys.





## How to Read the Screen Display

As Mouser starts, you will see the terrible situation Farmer Wheatbread is facing. The information below tells you about the screen display in front of you. When you are ready to start playing Mouser, select the 1 PLAYER or 2 PLAYER option described in the "Controls" section, which follows.

- TOP LEFT** = The time meter for scoring points when you capture mice
- TOP RIGHT** = The high score of all the games played
- BOTTOM RIGHT** = The scores for player 1 and player 2
- BOTTOM LEFT** = The number of farmers left (3-0)

The direction the walls will turn:

-  clockwise
-  counterclockwise

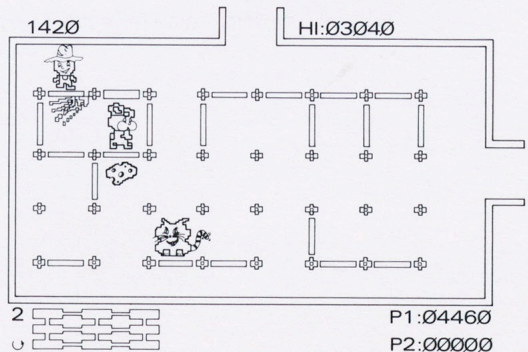

A map of the nine rooms



# Controls

## Game Options Control

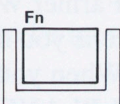
To select the  
1 PLAYER option  
and to stop/start  
a game at any time

Press  and  
then 

To select the  
2 PLAYER option  
and to stop/start  
a game at any time

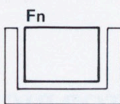
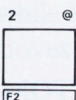
Press  and  
then 

To pause a game

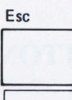
Press 

To continue a game

Press any key

For a slow/fast game

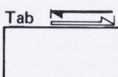
Press 

## Joystick Control

To use joystick control

Press and hold

then press

To advance your farmer

Move the joystick in the direction you want the farmer to take

To move the walls counterclockwise

Press and hold the joystick button

## Keyboard Control

To use keyboard control

Press and hold

then press

To move the walls clockwise or counterclockwise

Press the Spacebar

To move your farmer in the rooms:

Moves

up



Moves

left



Moves

right



Moves

down

## Scoring Points

Points are awarded to the player who captures a mouse within four walls, based on the time of capture. Each time a mouse is trapped the number on the time meter is added to the player's score. The time meter is reset at 2000 for each new farmer.

## Helpful Hints

**BEWARE!** You can lose a farmer if time runs out or if you are caught by a mouse.

The mice must be caged within four walls to receive points.

For a maximum score, remember to leave at least one female mouse in the room before entering another. If you return to that room, the female mouse may have eaten a piece of cheese and multiplied. This can increase your chance to capture more mice and accumulate more points.

Any wall that is being used to cage a mouse or enclose a piece of cheese or a cat cannot be moved.

If you push one wall into another, you create a double wall. The wall appears bright white and moves differently from the other walls. At this point, you must back up and push the double wall again to move one of the walls horizontally or vertically.

Notice when you come back into a room, the mice you've caged have disappeared - could it be

the cat  ...?

Help Farmer Wheatbread as fast as possible. Time is against you ... **GOOD LUCK!**

BEWARE! You could be caught by a mouse if you are caught by a mouse.

The mice must be caught within four walls to receive points.

For a gerbil to escape, it must be caught in the room before entering another. If you return to that room, the gerbil must have eaten a piece of cheese and multiplied. I believe this increases your chance to capture more mice and accumulate more points.

Any wall that is papered with to catch a mouse or another piece of cheese or a cat cannot be moved.

If you push one wall into another, the wall will move. The wall appears bright white and moves differently from the other walls. As the wall you push back up and push the double wall again to move one to the wall horizontally or vertically. When you push one wall into another, the mouse you've caught have disappeared - could it be?



the cat

Help! I'm tired! What should I do as fast as possible. Time is against you... GOOD LUCK!



## Reader's Comment Form

**Mouser**

**1502279**

Your comments assist us in improving the usefulness of our publication; they are an important part of the input used for revisions.

IBM may use and distribute any of the information you supply in any way it believes appropriate without incurring any obligation whatever. You may, of course, continue to use the information you supply.

Please do not use this form for technical questions regarding the IBM Personal Computer or programs for the IBM Personal Computer, or for requests for additional publications; this only delays the response. Instead, direct your inquiries or request to your authorized IBM Personal Computer dealer.

Comments:

IBM PERSONAL COMPUTER  
SERVICES & SUPPORT  
P.O. BOX 1338-C  
ARMONK, NY 10504

POSTAGE WILL BE PAID BY ADDRESSEE

NO POSTAGE  
NECESSARY  
IF MAILED  
IN THE  
UNITED STATES

**BUSINESS REPLY MAIL**

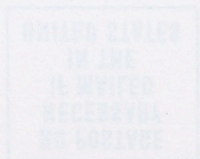
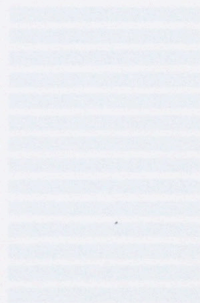

Fold here

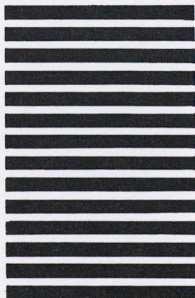

BOCA RATON, FLORIDA 33432  
P.O. BOX 1328-C  
SALES & SERVICE  
IBM PERSONAL COMPUTER

POSTAGE WILL BE PAID BY ADDRESSEE

**BUSINESS REPLY MAIL**  
FIRST CLASS PERMIT NO. 321 BOCA RATON, FLORIDA 33432

NO POSTAGE  
NECESSARY  
IF MAILED  
IN THE  
UNITED STATES







### Reader's Comment Form

**Mouser**

**1502279**

Your comments assist us in improving the usefulness of our publication; they are an important part of the input used for revisions.

IBM may use and distribute any of the information you supply in any way it believes appropriate without incurring any obligation whatever. You may, of course, continue to use the information you supply.

Please do not use this form for technical questions regarding the IBM Personal Computer or programs for the IBM Personal Computer, or for requests for additional publications; this only delays the response. Instead, direct your inquiries or request to your authorized IBM Personal Computer dealer.

Comments:

IBM PERSONAL COMPUTER  
SERIES 2 SERVICE  
IBM PERSONAL COMPUTER

POSTAGE WILL BE PAID BY ADDRESSEE

IBM CORPORATION, 400 RICHMOND ST., ARMONK, NY 10504

BUSINESS REPLY MAIL



Tape

Please do not staple

Tape

The Personal Computer  
Hardware Library

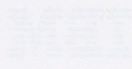

Header's Comment Form

1802378

Model

Your comments assist us in improving the usefulness of our publications; they are an important part of the input used for revisions.

IBM may use and distribute any of the information you supply in any way it believes appropriate without incurring any obligation whatever. You may, of course, continue to use the information you supply.

Please do not use this form for technical questions regarding the IBM Personal Computer or programs for the IBM Personal Computer or for requests for additional publications; this may delay the response. Instead, direct your inquiries to request for your authorized IBM Personal Computer dealer.

Fold here

Comments

IBM PERSONAL COMPUTER  
SALES & SERVICE  
P.O. BOX 1328-C  
BOCA RATON, FLORIDA 33432

POSTAGE WILL BE PAID BY ADDRESSEE

**BUSINESS REPLY MAIL**  
FIRST CLASS PERMIT NO. 321 BOCA RATON, FLORIDA 33432

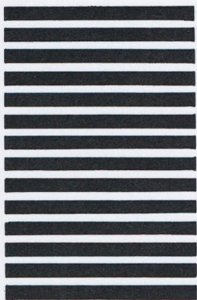

NO POSTAGE  
NECESSARY  
IF MAILED  
IN THE  
UNITED STATES



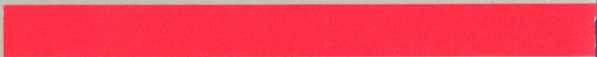

**System requirements:**

---



Video Display  
or Television  
(color preferred)

---

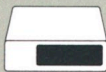

IBM PCjr

---

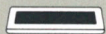

Keyboard

---

**Optional** 1 or 2 Joysticks

---